



RAV4 PRIME

RAV4 Plug-in Hybrid

Gasoline-Electric

Hybrid Synergy Drive

HYBRID VEHICLE DISMANTLING MANUAL



AXAP54 Series

This information is intended for use by professional dismantlers' only – Toyota New Zealand TNZ its officers, employees, agents, contractors, partners or suppliers accept no liability whatsoever for any loss, damage, liability or cost of any kind (whether in contract, tort (including negligence) or otherwise) arising directly or indirectly out of the use of this information.

Foreword

This guide was developed to educate and assist dismantlers in the safe handling of Toyota RAV4 PRIME, RAV4 Plug-in Hybrid gasoline-electric hybrid vehicles. RAV4 PRIME, RAV4 Plug-in Hybrid dismantling procedures are similar to other non-hybrid Toyota vehicles with the exception of the high voltage electrical system. It is important to recognize and understand the high voltage electrical system features and specifications of the Toyota RAV4 PRIME, RAV4 Plug-in Hybrid, as they may not be familiar to dismantlers.

High voltage electricity powers the A/C compressor, electric motors, generator, and inverter/converter. All other conventional automotive electrical devices such as the head lights, radio, and gauges are powered from a separate 12 Volt auxiliary battery. Numerous safeguards have been designed into the RAV4 PRIME, RAV4 Plug-in Hybrid to help ensure the high voltage, approximately 355.2 Volt, Lithium-ion (Li-ion) Hybrid Vehicle (HV) battery pack is kept safe and secure in an accident.

The Lithium-ion battery pack contains sealed batteries that are similar to rechargeable batteries used in some battery operated power tools and other consumer products. The electrolyte is absorbed in the cell plates and will not normally leak out even if the battery is cracked. If the electrolyte is leaking, do not touch any leaked liquid because it could be the organic electrolyte that contains carbonate ester-based. If contact is unavoidable, wipe up the liquid using a cloth while wearing rubber gloves, goggles and an organic solvent mask. Do not leave electrolyte-contaminated cloths unattended. Please contaminated cloths in an appropriate airtight container and dispose of them according to local regulations.

High voltage cables, identifiable by orange insulation and connectors, are isolated from the metal chassis of the vehicle.

Additional topics contained in the guide include:

- Toyota RAV4 PRIME, RAV4 Plug-in Hybrid identification.
- Major hybrid component locations and descriptions.

By following the information in this guide, dismantlers will be able to handle RAV4 PRIME, RAV4 Plug-in Hybrid hybrid-electric vehicles as safely as the dismantling of a conventional gasoline engine automobile.

For additional information contact 0800 TOYOTA or your local Toyota dealer.

© 2020 Toyota Motor Corporation

All rights reserved. This book may not be reproduced or copied, in whole or in part, without the written permission of Toyota Motor Corporation.

Table of Contents

<u>About the RAV4 PRIME, RAV4 Plug-in Hybrid</u>	<u>1</u>
<u>RAV4 PRIME, RAV4 Plug-in Hybrid Identification</u>	<u>2</u>
Exterior	<u>3</u>
Interior.....	<u>4</u>
Engine Compartment.....	<u>5</u>
<u>Hybrid Component Locations & Descriptions</u>	<u>6</u>
Specifications.....	<u>8</u>
<u>Hybrid Synergy Drive Operation</u>	<u>9</u>
Vehicle Operation.....	<u>9</u>
<u>Hybrid Vehicle (HV) Battery Pack and Auxiliary Battery</u>	<u>10</u>
HV Battery Pack.....	<u>10</u>
Components Powered by the HV Battery Pack.....	<u>10</u>
HV Battery Pack Recycling	<u>11</u>
Auxiliary Battery	<u>11</u>
<u>High Voltage Safety</u>	<u>12</u>
High Voltage Safety System	<u>12</u>
Service Plug Grip	<u>13</u>
<u>Precaution to be observed when dismantling the vehicle</u>	<u>14</u>
Necessary Items	<u>14</u>
<u>Spills</u>	<u>15</u>
<u>Dismantling the vehicle</u>	<u>16</u>
<u>Removal of HV battery</u>	<u>21</u>

About the RAV4 PRIME, RAV4 Plug-in Hybrid

The RAV4 PRIME, RAV4 Plug-in Hybrid contains a gasoline engine, an electric motor, and a developed large capacity Li-ion battery. It is the Toyota hybrid that allows the HV battery to be plugged-in and charged by an external power source.

The two hybrid power sources are stored on board the vehicle:

1. Gasoline stored in the fuel tank for the gasoline engine.
2. Electricity stored in a large capacity externally chargeable high voltage Hybrid Vehicle (HV) battery assembly for the electric motor.

Depending on the driving conditions, one or both sources are used to power the vehicle. The following illustration demonstrates how the RAV4 PRIME, RAV4 Plug-in Hybrid operates in various driving modes.

EV (Electric Vehicle) Mode:

- ❶ A plug-in charge control system has been adopted, which allows electrical power to be supplied to the HV battery from external power source such as an electrical socket or charger.
- ❷ When the HV battery is sufficiently charged, the vehicle will basically run on the power of the motor.
- ❸ If the vehicle exceeds 135 km/h or accelerates suddenly when traveling in plug-in EV mode, the gasoline engine and motor work together to power the vehicle.

HV (Hybrid Vehicle) Mode:

- ❹ During light acceleration at low speeds, the vehicle is powered by the electric motor. The gasoline engine is shut off.
- ❺ During normal driving, the vehicle is powered mainly by the gasoline engine. The gasoline engine also powers the generator to recharge the battery assembly and to drive the motor.
- ❻ During full acceleration, such as climbing a hill, both the gasoline engine and the electric motor power the vehicle.
- ❼ During deceleration, such as when braking, the vehicle regenerates the kinetic energy from the wheels to produce electricity that recharges the battery assembly.
- ❽ While the vehicle is stopped, the gasoline engine and electric motor are off, however the vehicle remains on and operational.

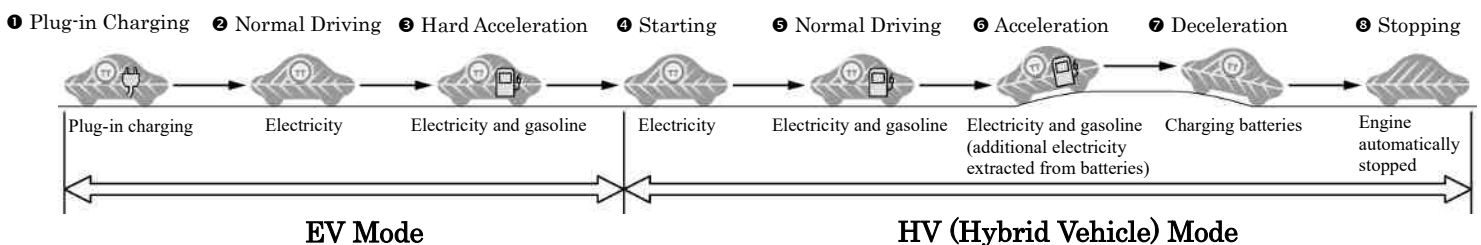

RAV4 PRIME, RAV4 Plug-in Hybrid Identification

In appearance, the 2020 model year RAV4 PRIME, RAV4 Plug-in Hybrid is nearly identical to the conventional, non-hybrid Toyota RAV4. The RAV4 PRIME, RAV4 Plug-in Hybrid is a 5-door wagon. Exterior, interior, and engine compartment illustrations are provided to assist in identification.

The alphanumeric 15 character Vehicle Identification Number (VIN) is provided on the left side windshield cowl, floor under the right side front seat and left side B pillar.

Example VIN:

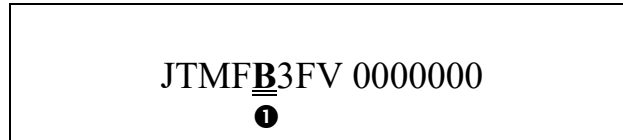

A RAV4 PRIME, RAV4 Plug-in Hybrid is identified by the 5th alphanumeric character of the VIN.

①	Engine Series	Drive Type	Battery Type
B	A25A-FXS	4WD	Lithium-ion Battery

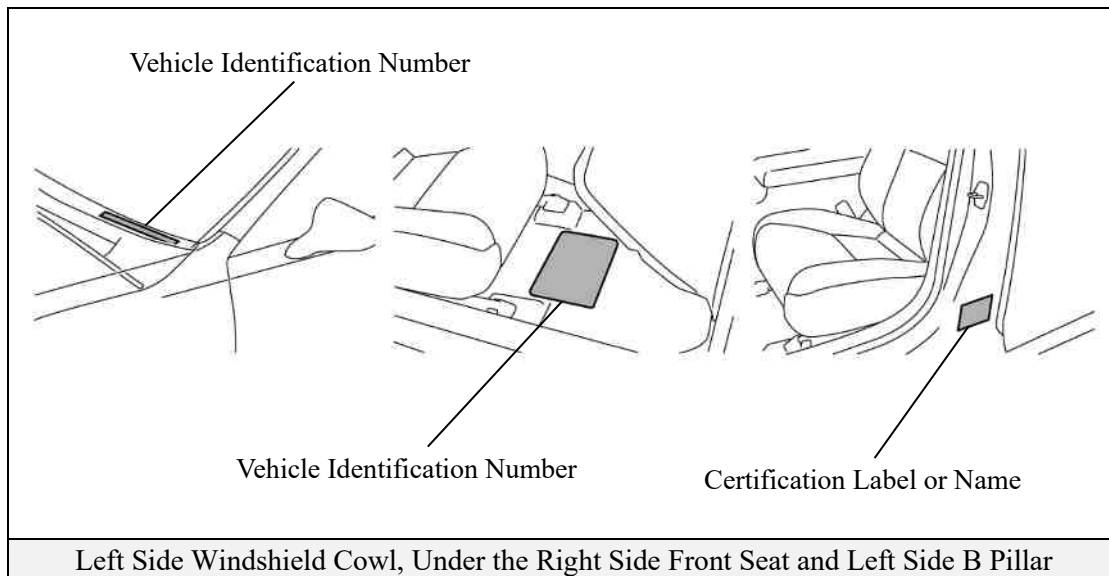

Exterior

- ❶  logos on the back door and each front fender.
- ❷ Gasoline fuel filler door located on left side rear quarter panel.



Exterior Front and Left Side View



Exterior Rear and Left Side View

Interior

- ③ The instrument cluster (hybrid system indicator, **READY** indicator and warning lights) located in the dash behind the steering wheel, is different than the one on the conventional, non-hybrid RAV4.
- ④ In Place of a tachometer, a hybrid system indicator is used to show power output.

NOTICE:

If the vehicle is shut off, the instrument cluster gauges will be “blacked out”, not illuminated.

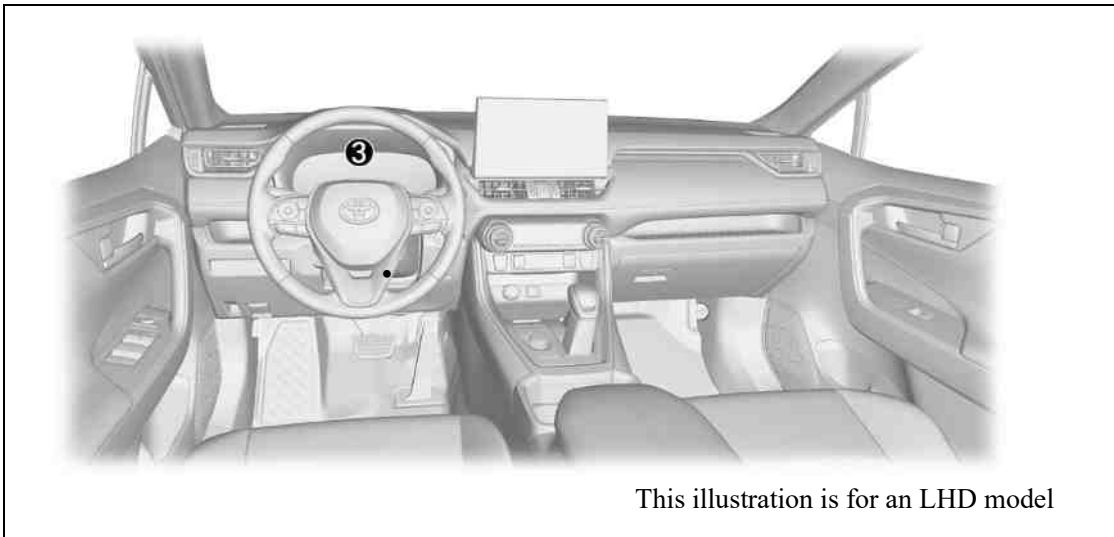

Interior View

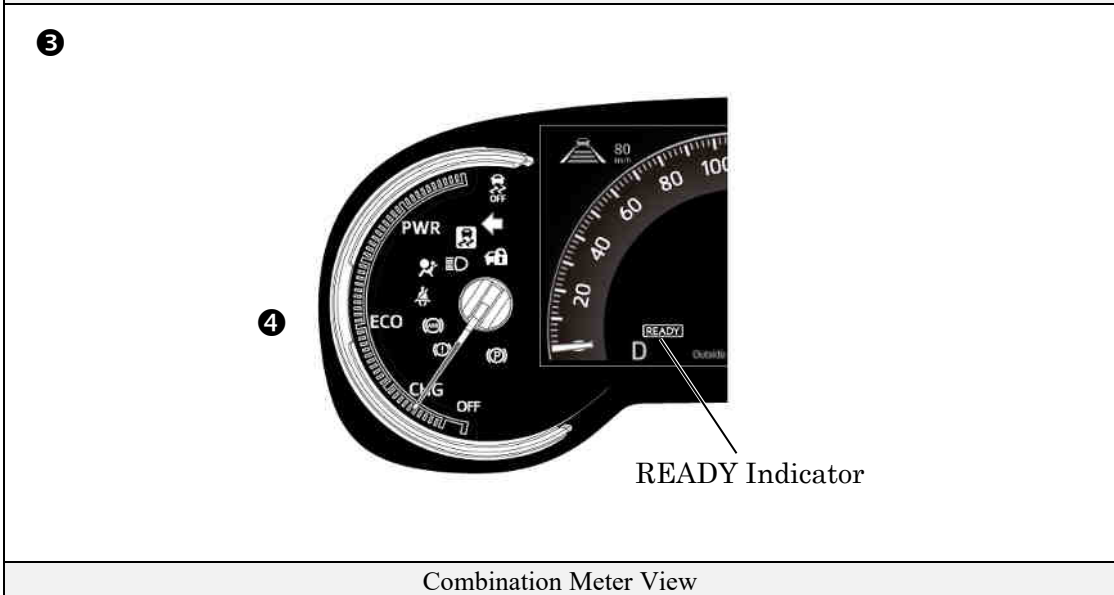

Engine Compartment

- ⑤ 2.5-liter aluminum alloy gasoline engine.
- ⑥ Orange colored high voltage power cables.
- ⑦ Charge inlet door located on the right side rear quarter panel.

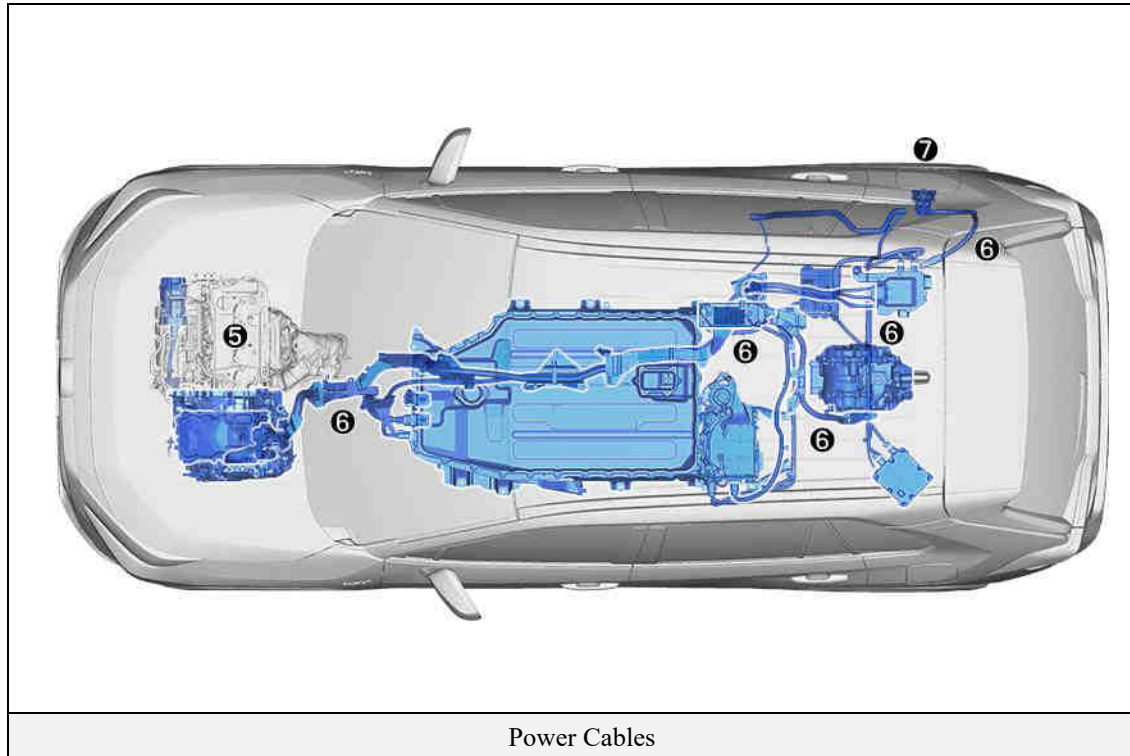

Hybrid Component Locations & Descriptions

Component	Location	Description
12 Volts Auxiliary Battery ❶	Luggage Compartment Area	Supplies electricity to the electrical components.
Hybrid Vehicle (HV) Battery Pack ❷	Undercarriage	<ul style="list-style-type: none"> · Supplies electrical power to MG1, MG2 and MGR in accordance with the driving conditions of the vehicle. · Recharged by MG1, MG2 and MGR in accordance with the SOC and the driving conditions of the vehicle.
Power Cables ❸	Undercarriage and Engine Compartment	Connects the HV battery, hybrid motor control inverter assembly, hybrid vehicle transaxle assembly and compressor with motor assembly.
Inverter/Converter ❹	Engine Compartment	<ul style="list-style-type: none"> · Converts the direct current from the boost converter into alternating current for MG1, MG2 and MGR, and vice versa (from AC to DC). · Boosts the HV battery nominal voltage of DC 355.2 Volts up to a maximum voltage of DC 650 Volts and vice versa (steps down DC 650 Volts to DC 355.2 Volts).
Gasoline Engine ❺	Engine Compartment	<p>Provides two functions:</p> <ol style="list-style-type: none"> 1) Powers vehicle. 2) Powers generator to recharge the HV battery pack. <p>The engine is started and stopped under control of the vehicle computer.</p>

Component	Location	Description
Front Electric Motor ⑥	Engine Compartment	<ul style="list-style-type: none"> · MG2, which is driven by electrical power from MG1 and the HV battery, generates motive force for the drive wheels. · During braking, or when the accelerator pedal is not depressed, it generates high-voltage electricity to recharge the HV battery.
Electric Generator ⑦	Engine Compartment	MG1, which is driven by the engine, generates high-voltage electricity in order to operate MG2 and charge the HV battery. Also, it functions as a starter to start the engine.
A/C Compressor (with inverter) ⑧	Engine Compartment	3-phase high voltage AC electrically driven motor compressor.
DC-DC Converter for 12 Volts Auxiliary Battery ⑨	Cabin Area, Under Rear Seat	Steps down the HV battery nominal voltage of DC 355.2 Volts to approximately DC 14 Volts in order to supply electricity to the electrical components, as well as to recharge the auxiliary battery.
Rear Electric Motor ⑩	Rear Sub-Frame	<ul style="list-style-type: none"> · MGR, which is driven by electrical power from MG1 and the HV battery, generates motive force for the drive wheels. · During braking, or when the accelerator pedal is not depressed, it generates high-voltage electricity to recharge the HV battery.
Fuel Tank and Fuel Line ⑪	Undercarriage and Center	The fuel tank provides gasoline via a fuel line to the engine. The fuel line is routed under the center of vehicle.

*Numbers in the component column apply to the illustrations on the following page.

Specifications

Gasoline Engine: 131 kW, 2.5-liter Aluminum Alloy Engine

Electric Motors

Front: 134 kW, Permanent Magnet Synchronous Motor

Rear: 40 kW, Permanent Magnet Synchronous Motor

Transmission: Automatic Only

HV Battery: 355.2 Volt Sealed Li-ion-Battery

Curb Weight: 4,211-4,409 lbs/1,910-2,000 kg

Fuel Tank: 12.1 Imp gals/14.5 U.S. gals/55 liters

Frame Material: Steel Unibody

Body Material: Steel Panels

Seating Capacity: 5 passenger

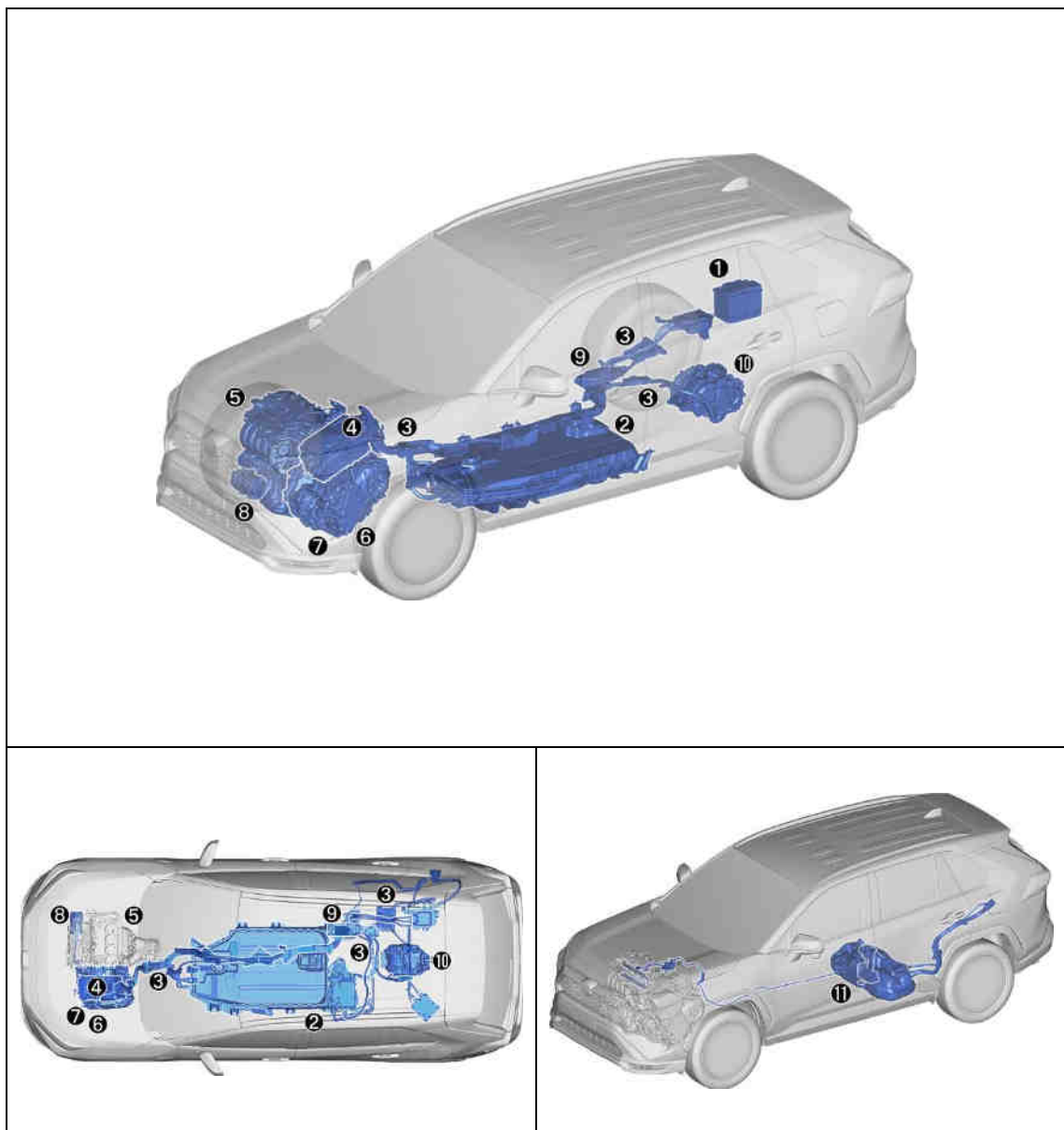

Hybrid Synergy Drive Operation

Once the **READY** indicator is illuminated in the instrument cluster, the vehicle may be driven. However, the gasoline engine does not idle like a typical automobile and will start and stop automatically. It is important to recognize and understand the **READY** indicator provided in the instrument cluster. When illuminated, it informs the driver that the vehicle is on and operational even though the gasoline engine may be off and the engine compartment is silent.

Vehicle Operation

- With the RAV4 PRIME, RAV4 Plug-in Hybrid, the gasoline engine may stop and start at any time while the **READY** indicator is on.
- Never assume that the vehicle is shut off just because the engine is off. Always look for the **READY** indicator status. The vehicle is shut off when the **READY** indicator is off.

The vehicle may be powered by:

1. The electric motors only.
2. A combination of both the electric motors and the gasoline engine.

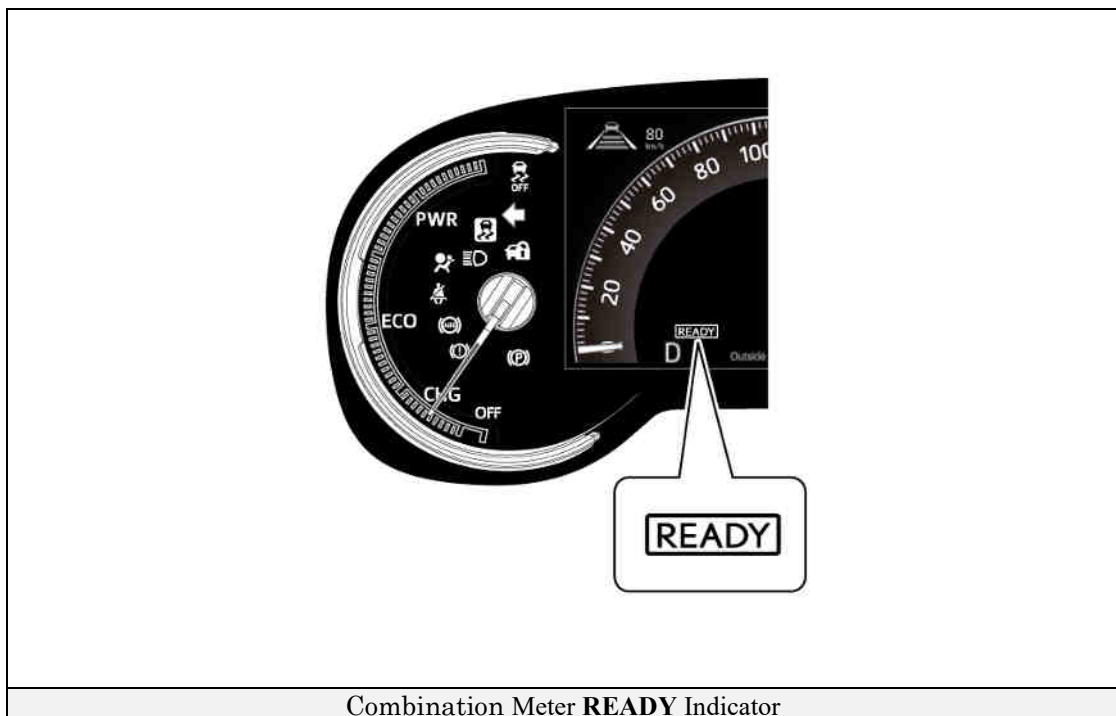

Hybrid Vehicle (HV) Battery Pack and Auxiliary Battery

The RAV4 PRIME, RAV4 Plug-in Hybrid features a high voltage Hybrid Vehicle (HV) battery pack that contains sealed Lithium-ion (Li-ion) battery cells.

HV Battery Pack

- The HV battery pack is enclosed in a metal case and is rigidly mounted to the undercarriage. The metal case is isolated from high voltage.
- The HV battery pack consists of 96 low voltage (3.7 Volts) Li-ion battery cells connected in series to produce approximately 355.2 Volts. Each Li-ion battery module is non-spillable and sealed in a metal case.
- The electrolyte used in the Li-ion battery module is an alkaline mixture of potassium and sodium hydroxide. The electrolyte is absorbed into the battery cell plates and will not normally leak, even in a collision.

HV Battery Pack	
Battery pack voltage	355.2 Volts
Number of Li-ion battery cells in the pack	96
Li-ion battery module voltage	3.7 Volts

Components Powered by the HV Battery Pack

- Front Electric Motor
- Rear Electric Motor
- Power Cables
- A/C Compressor
- Electric Generator
- Inverter/Converter
- DC-DC Converter for 12 Volts Auxiliary Battery

HV Battery Pack Recycling

- The HV battery pack is recyclable. Contact either your Toyota distributor as mentioned on the caution label on the HV battery or the nearest Toyota dealer.

Auxiliary Battery

- The RAV4 PRIME, RAV4 Plug-in Hybrid also contains a sealed lead-acid 12 Volts battery. This 12 Volts auxiliary battery powers the vehicle electrical system similar to a conventional vehicle. As with other conventional vehicles, the auxiliary battery is grounded to the metal chassis of the vehicle.
- The auxiliary battery is located under the luggage compartment area. It is concealed by a plastic resin cover on the right side in the battery compartment.

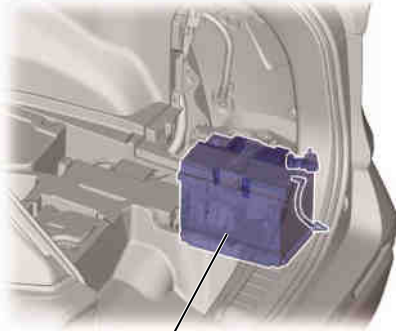
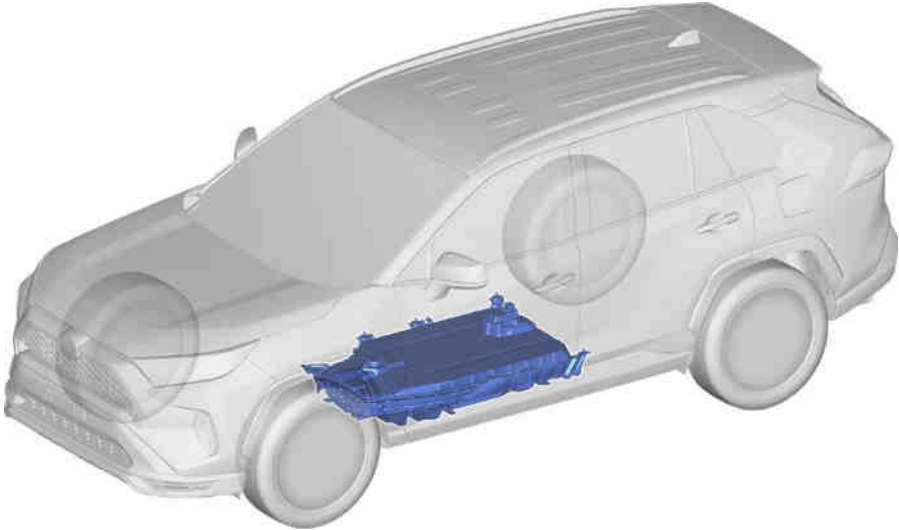
	 <p>Auxiliary Battery</p>
355.2 Volts HV Battery Pack	12 Volts Auxiliary Battery Mounted in Luggage Compartment Area (Right Side)
	
HV Battery Pack Mounted in Undercarriage	

High Voltage Safety

The HV battery pack powers the high voltage electrical system with DC electricity. Positive and negative orange colored high voltage power cables are routed from the battery pack, under the vehicle floor pan, to the inverter/converter, A/C compressor, DC/DC converter and voltage inverter assembly. The inverter/converter contains a circuit that boosts the HV battery voltage from 355.2 to 650 Volts DC. The inverter/converter creates 3-phase AC to power the motors. Power cables are routed from the inverter/converter to each high voltage motors (front and rear electric motors, and electric generator). The following systems are intended to help keep occupants in the vehicle and emergency responders safe from high voltage electricity:

High Voltage Safety System

- Positive and negative high voltage power cables ❶* connected to the HV battery pack are controlled by 12 Volts normally open relays ❷*. When the vehicle is shut off, the relays stop electricity flow from leaving the HV battery pack.



WARNING:

- ***The high voltage system may remain powered for up to 10 minutes after the vehicle is shut off or disabled. To prevent serious injury or death from severe burns or electric shock, avoid touching, cutting, or opening any orange high voltage power cable or high voltage component.***

- Both positive and negative power cables ❶* are insulated from the metal body. High voltage electricity flows through these cables and not through the metal vehicle body. The metal vehicle body is safe to touch because it is insulated from the high voltage components.
- A ground fault monitor ❸* continuously monitors for high voltage leakage to the metal chassis while the vehicle is running. If a malfunction is detected, the hybrid vehicle computer ❹* will a message indicating that the hybrid system is malfunctioning will be displayed on the multi-information display.
- The HV battery pack relays will automatically open to stop electricity flow in a collision sufficient to activate the SRS.

*Numbers apply to the illustration on the following page.

High Voltage Safety (Continued)

Service Plug Grip

- The high voltage circuit is cut by removing the service plug grip (see page 16).

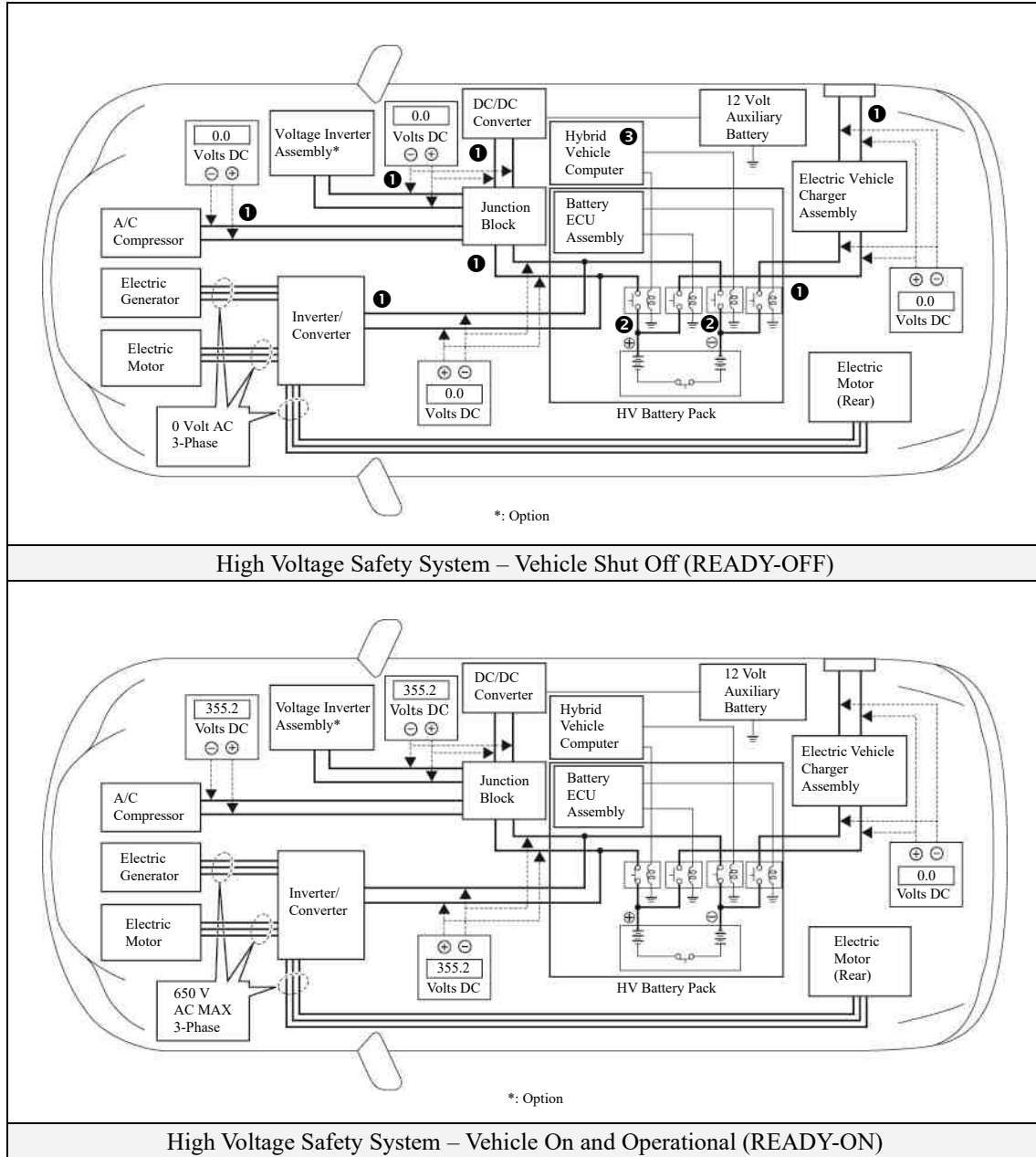

Precaution to be observed when dismantling the vehicle



WARNING:

- *The high voltage system may remain powered for up to 10 minutes after the vehicle is shut off or disabled. To prevent serious injury or death from severe burns or electric shock, avoid touching, cutting, or opening any orange high voltage power cable or high voltage component.*

Necessary Items

- Protective clothing such as insulated gloves (electrically insulated), rubber gloves, safety goggles, and safety shoes.
- Insulating tape such as electrical tape that has a suitable electrical insulation rating.
- Before wearing insulated gloves, make sure that they are not cracked, ruptured, torn, or damaged in any way. Do not wear wet insulated gloves.
- An electrical tester that is capable of measuring DC 750 Volts or more.

Spills

The RAV4 PRIME, RAV4 Plug-in Hybrid contains the same common automotive fluids used in other non-hybrid Toyota vehicles, with the exception of the Li-ion electrolyte used in the HV battery pack. The electrolyte used in the Li-ion battery cells is a flammable organic electrolyte. The electrolyte is absorbed into the battery cell separators, even if the battery cells are crushed or cracked, it is unlikely that liquid electrolyte will leak. Any liquid electrolyte that leaks from a Li-ion battery cell quickly evaporates.



WARNING:

- ***The Li-ion battery contains organic electrolyte. Only a small amount may leak from the batteries which may irritate the eyes, nose, throat, and skin.***
- ***Contact with the vapor produced by the electrolyte may irritate the nose and throat.***
- ***To avoid injury by coming in contact with the electrolyte or vapor, wear personal protective equipment for organic electrolyte including SCBA or protective mask for organic gases.***

- Handle Li-ion electrolyte spills using the following Personal Protective Equipment (PPE):
 - Splash shield or safety goggles. A fold down face shield is not acceptable for acid or electrolyte spills.
 - Rubber gloves or gloves suitable for organic solvents.
 - Apron suitable for organic solvents.
 - Rubber boots or boots suitable for organic solvents.
 - Protective mask for organic gases or SCBA.

Dismantling the vehicle

The following 5 pages contain general instructions for use when working on a RAV4 PRIME, RAV4 Plug-in Hybrid.

Read these instructions before proceeding to the HV battery removal instructions on page 21.



WARNING:

- ***The high voltage system may remain powered for up to 10 minutes after the vehicle is shut off or disabled. To prevent serious injury or death from severe burns or electric shock, avoid touching, cutting, or opening any orange high voltage power cable or any high voltage component.***

1. Shut off the ignition (**READY** indicator is off).
2. Remove deck board assembly
 - (1) Remove the deck board assembly.



3. Remove battery hole cover
 - (1) Detach the 13 claws and remove the battery hole cover.

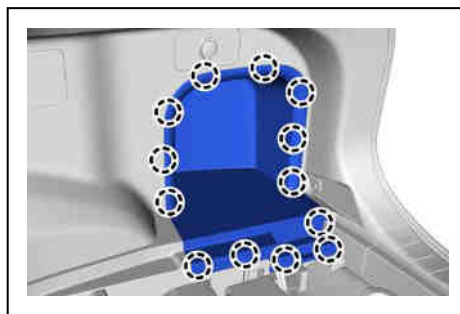

4. Disconnect cable from negative auxiliary battery terminal
 - (1) Loosen the nut, and disconnect the cable from the negative (-) auxiliary battery terminal.



- (2) Set the negative (-) auxiliary battery terminal to the deck trim side panel assembly RH.

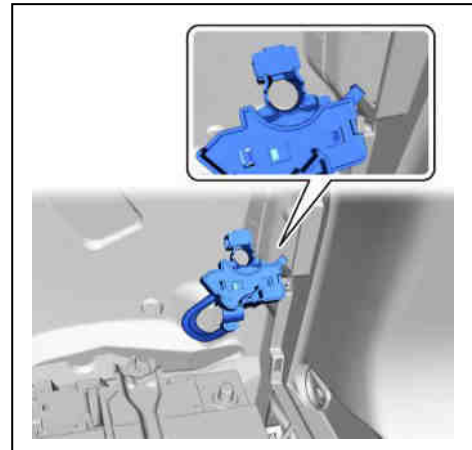

5. Remove battery service hole cover

- (1) Disengage the 4 clips to remove the battery service hole cover.

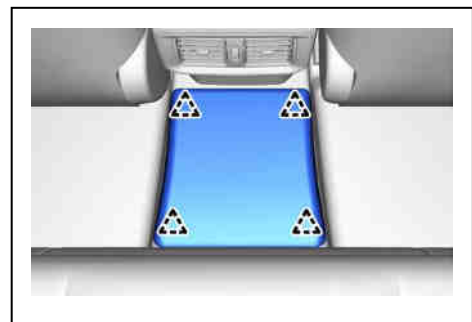

6. Remove front floor service hole cover

- (1) Remove the 3 bolts and front floor service hole cover.

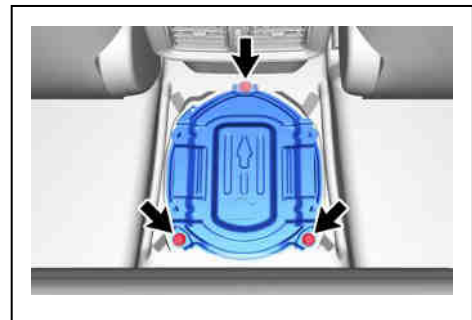

7. Remove No. 2 traction battery cover

- (1) Remove the 4 bolts and No. 2 traction battery cover.

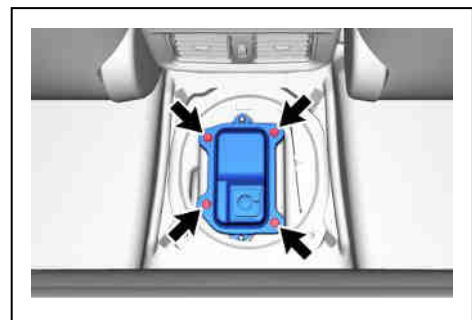

8. Remove service plug grip

CAUTION:

- Be sure to wear insulated gloves.
- Do not inspect or service the high voltage system with the service plug grip installed.
- To reduce the risk of electric shock, make sure to remove the service plug grip to cut off the high voltage circuit before servicing the vehicle.
- To reduce the risk of electric shock, make sure to wait at least 10 minutes after removing the service plug grip to fully discharge the high voltage capacitor inside the hybrid motor control inverter assembly.
- Keep the removed service plug grip in your pocket to prevent other technicians from accidentally installing it while you are servicing the vehicle.



NOTICE:

- After removing the service plug grip, turning the ignition switch to ON (READY) may cause a malfunction.
- Do not touch the terminals of the service plug grip.

HINT:

Waiting for at least 10 minutes is required to discharge the high voltage capacitor inside the hybrid motor control inverter assembly.

- (1) While wearing insulated gloves, rotate the handle of the service plug grip and remove the service plug grip as indicated by the arrows, in the order shown in the illustration.

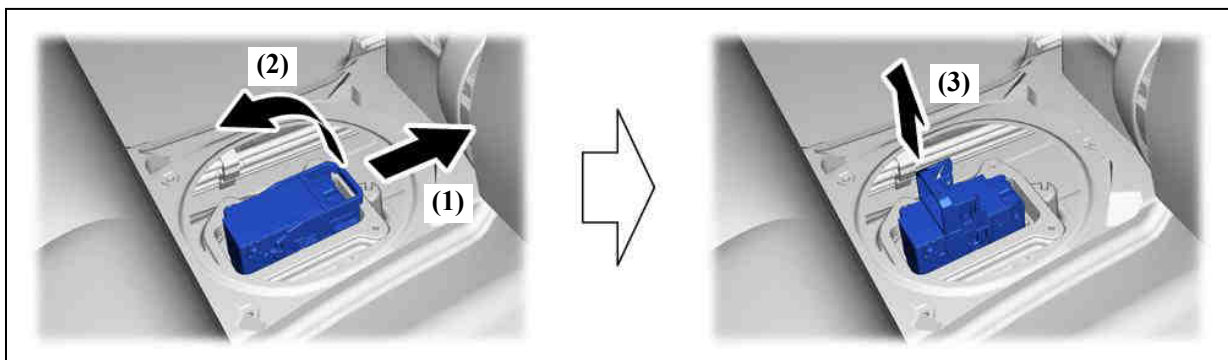

9. Make other staff aware that a high-voltage system is being dismantled by using the following sign: CAUTION: HIGH-VOLTAGE. DO NOT TOUCH (see page 20).

10. If the service plug grip cannot be removed due to damage to the vehicle, remove the **IGCT SCENE NO. 2** fuse (7.5 A).

CAUTION:

This operation shuts off the HV system. Be sure to wear insulated gloves because high voltage is not shut off inside the HV battery. When it is possible to remove the service plug grip, remove it and continue the procedure.

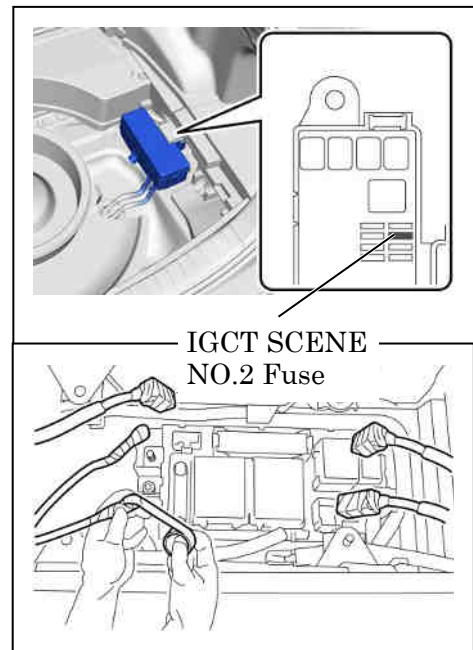

11. After disconnecting or exposing a high-voltage connector or terminal, insulate it immediately using insulating tape. Before disconnecting or touching a bare high-voltage terminal, wear insulated gloves.

12. Check the HV battery and nearby area for leakage. If you find any liquid, wear rubber gloves and goggles, and wipe up the liquid using waste rags etc.

13. If the electrolyte comes into contact with your skin, wash the skin immediately using a large amount of water and a soap. If the electrolyte adheres to any article of clothing, take the clothing off immediately.

14. If the electrolyte comes into contact with your eye(s), call out loudly for help. Do not rub your eye(s). Instead, wash the eye(s) with a large amount of water and seek medical care.

15. With the exception of the HV battery, remove parts by following procedures which are similar to conventional Toyota vehicles. For the removal of the HV battery, refer to the following pages.

Person in charge: _____

CAUTION:
HIGH-VOLTAGE.
DO NOT TOUCH.

CAUTION:
HIGH-VOLTAGE.
DO NOT TOUCH.

Person in charge: _____

When performing work on the HV system, fold this sign and
put it on the roof of the vehicle.

Removal of HV battery



WARNING:

- **Be sure to wear insulated gloves when handling high-voltage parts.**
- **Even if the vehicle is shut off and the relays are off, be sure to remove the service plug grip before performing any further work.**
- **Power remains in the high voltage electrical system for 10 minutes even after the HV battery pack is shut off because the circuit has a condenser that stores power.**
- **Make sure that the tester reading is 0 Volt before touching any high-voltage terminals which are not insulated.**
- **The SRS may remain powered for up to 90 seconds after the vehicle is shut off or disabled. To prevent serious injury or death from unintentional SRS deployment, avoid cutting the SRS components.**

1. RECOVER REFRIGERANT FROM REFRIGERATION SYSTEM
2. SHUT OFF IGINATION (**READY** indicator is off)
3. REMOVE DECK BOARD ASSEMBLY

(1) Remove the deck board assembly.



4. REMOVE BATTERY HOLE COVER

(1) Detach the 13 claws and remove the battery hole cover.

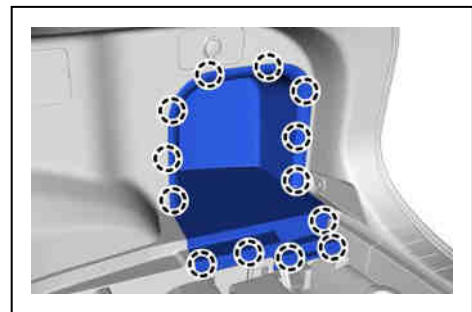

5. DISCONNECT CABLE FROM NEGATIVE AUXILIARY BATTERY TERMINAL

(1) Loosen the nut, and disconnect the cable from the negative (-) auxiliary battery terminal.



(2) Set the negative (-) auxiliary battery terminal to the deck trim side panel assembly RH.

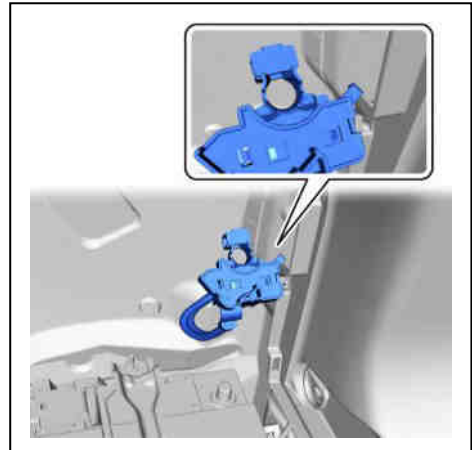

6. REMOVE BATTERY SERVICE HOLE COVER

(1) Disengage the 4 clips to remove the battery service hole cover.

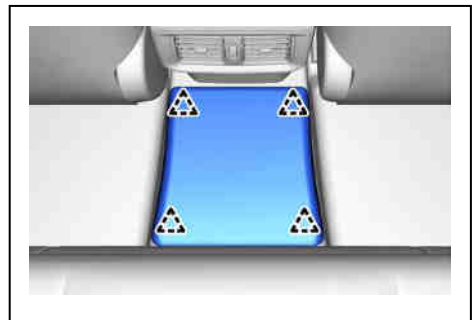

7. REMOVE FRONT FLOOR SERVICE HOLE COVER

(1) Remove the 3 bolts and front floor service hole cover.

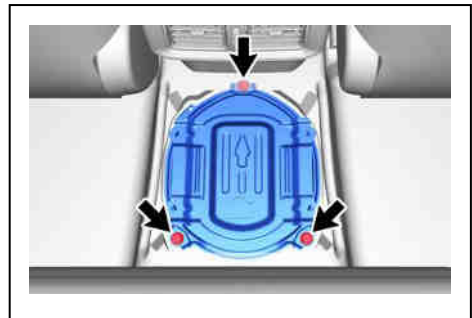

8. REMOVE NO. 2 TRACTION BATTERY COVER

(1) Remove the 4 bolts and No. 2 traction battery cover.

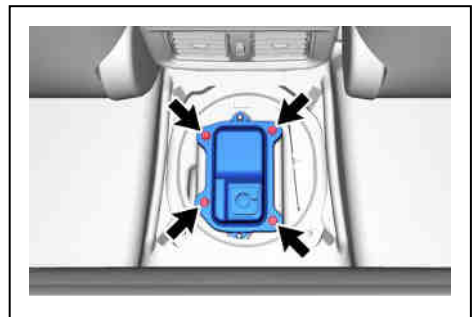

9. REMOVE SERVICE PLUG GRIP

CAUTION:

- Be sure to wear insulated gloves.
- Do not inspect or service the high voltage system with the service plug grip installed.
- To reduce the risk of electric shock, make sure to remove the service plug grip to cut off the high voltage circuit before servicing the vehicle.
- To reduce the risk of electric shock, make sure to wait at least 10 minutes after removing the service plug grip to fully discharge the high voltage capacitor inside the hybrid motor control inverter assembly.
- Keep the removed service plug grip in your pocket to prevent other technicians from accidentally installing it while you are servicing the vehicle.

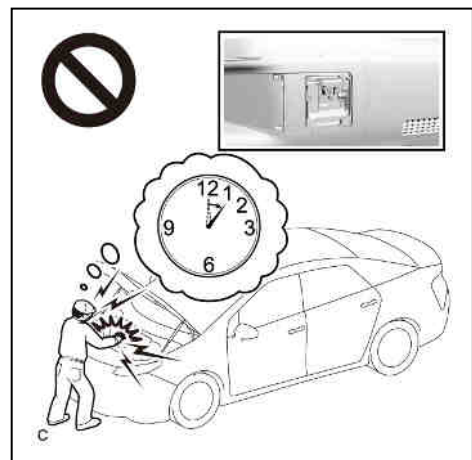
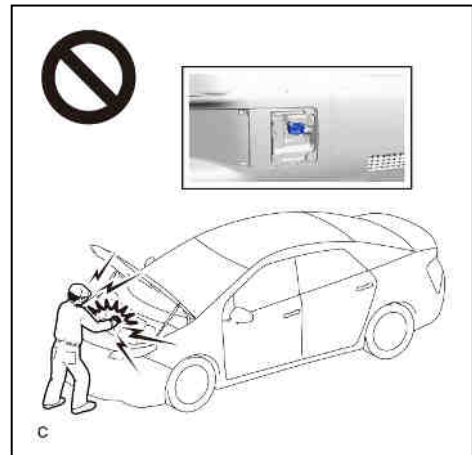

NOTICE:

- After removing the service plug grip, turning the ignition switch to ON (READY) may cause a malfunction.
- Do not touch the terminals of the service plug grip.

HINT:

Waiting for at least 10 minutes is required to discharge the high voltage capacitor inside the hybrid motor control inverter assembly.

- (1) While wearing insulated gloves, rotate the handle of the service plug grip and remove the service plug grip as indicated by the arrows, in the order shown in the illustration.

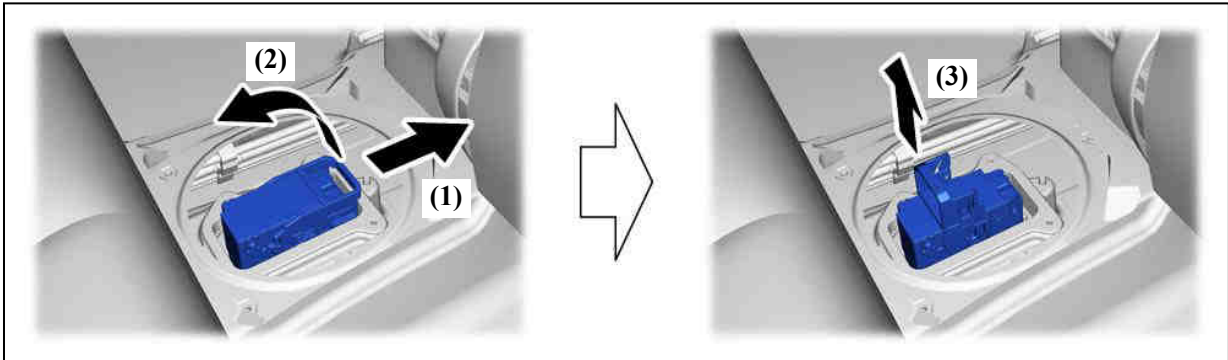

CAUTION:

- Do not allow any foreign matter to fall into the HV supply battery assembly.
- Take steps to prevent foreign material from falling into the HV supply battery assembly after removing the service plug grip.

10. REMOVE NO. 2 INVERTER PROTECTOR

- (1) Remove the 2 bolts and No. 2 inverter protector from the hybrid motor control inverter assembly.

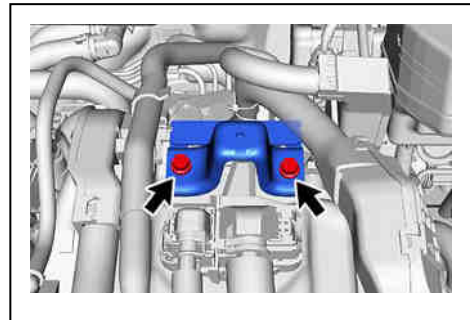

11. REMOVE CONNECTOR COVER ASSEMBLY

CAUTION:

Be sure to wear insulated gloves.

- (1) Remove the 2 bolts (A).
- (2) Using a T25 "TORX" socket wrench, remove the bolt (B) and connector cover assembly from the hybrid motor control inverter assembly.

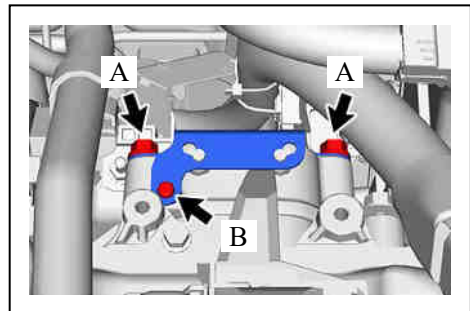

NOTICE:

- Do not allow any foreign matter or water to enter the hybrid motor control inverter assembly.

13. CHECK TERMINAL VOLTAGE

CAUTION:

Be sure to wear insulated gloves.

- (1) Using a voltmeter, measure the voltage between the terminals of the 2 phase connectors.

Standard voltage: 0 V

NOTICE:

Do not allow any foreign matter or water to enter the hybrid motor control inverter assembly.

HINT:

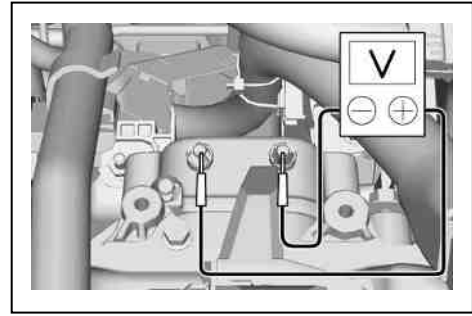

Use a measuring range of DC 750 Volt or more on the voltmeter.

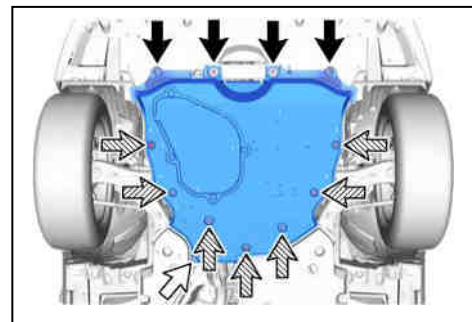

14. REMOVE NO. 2 ENGINE UNDER COVER ASSEMBLY

- (1) Remove the 4 bolts, screw, 7 clips and No. 2 engine under cover assembly.





	Bolt
	Screw
	Clip

15. REMOVE FRONT FLOOR COVER LH

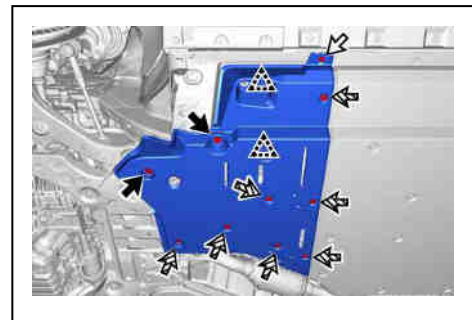
- (1) Remove the 2 bolts, screw and 7 clips.
- (2) Detach the clips and remove the front floor cover LH.





	Bolt
	Screw
	Clip

17. REMOVE NO. 2 FLOOR UNDER COVER

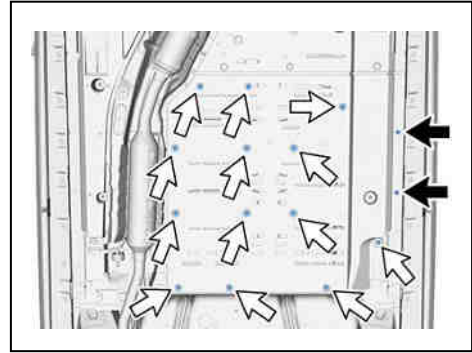
- (1) Remove the 2 screws and 13 clips.



	Screw
	Clip

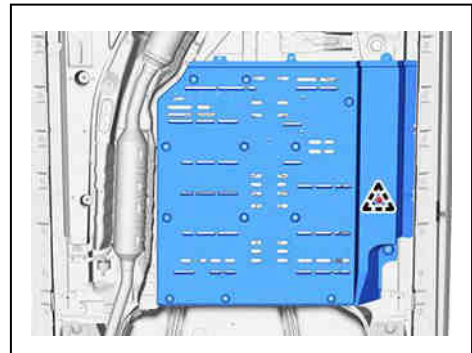

- (2) Disengage the clip and remove the No. 2 floor under cover.

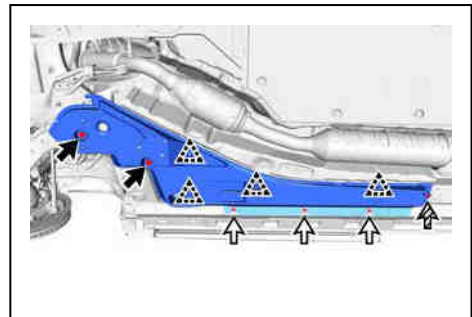

18. REMOVE FRONT FLOOR COVER RH

- (1) Remove the 2 bolts, 3 screws and clip.
- (2) Detach the clips and remove the front floor cover RH.



	Bolt
	Screw
	Clip

20. REMOVE ENGINE UNDER COVER HEAT INSULATOR

- (1) Using the service plug grip, remove the No.23 traction battery bracket.

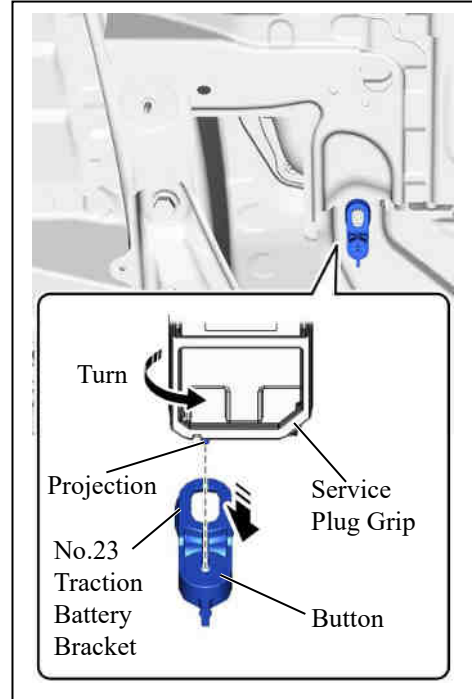

HINT:

Insert the projection of the service plug grip and turn the button of the No.23 traction battery bracket counterclockwise to release the lock.

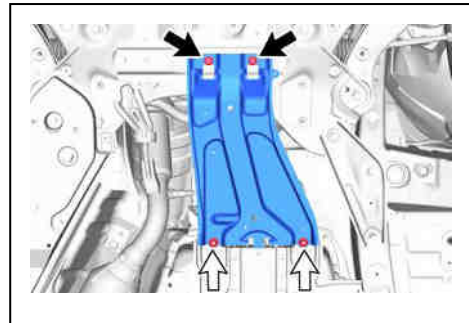

- (2) Remove the 2 bolts, 2 nuts and engine under cover heat insulator.



	Bolt
	Nut

21. REMOVE FRONT EXHAUST PIPE ASSEMBLY

CAUTION:

To prevent burns, do not touch the engine, exhaust pipe or other high temperature components while the engine is hot.

- (1) Detach the wire harness clamp.
- (2) Disconnect the air fuel ratio sensor (for Sensor 2) connector.

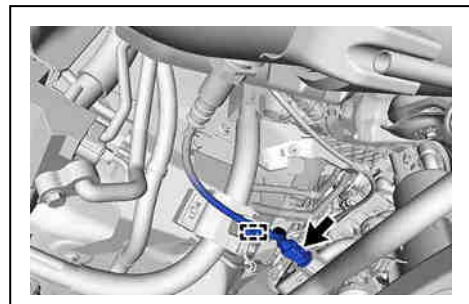

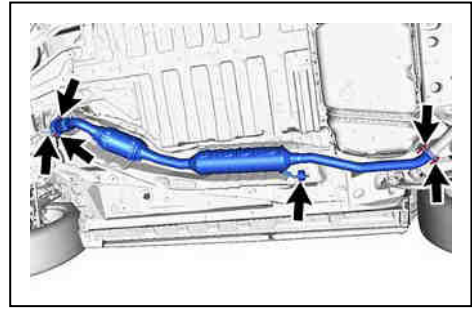

- (3) Remove the 2 bolts, 2 nuts and disconnect the front exhaust pipe assembly from the exhaust manifold and tail exhaust pipe assembly.
- (4) Remove the front exhaust pipe assembly from the 2 exhaust pipe supports.
- (5) Remove the 2 gaskets from the front exhaust pipe assembly.

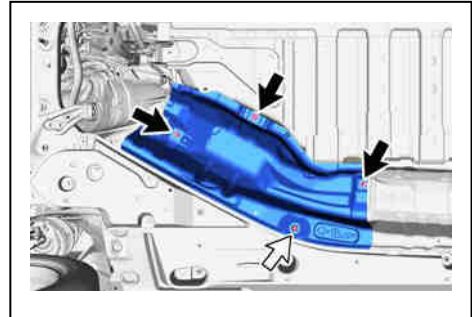

22. REMOVE FRONT NO. 2 FLOOR HEAT INSULATOR

- (1) Remove the 3 nuts, clip and front No. 2 floor heat insulator.





	Nut
	Clip

23. REMOVE FRONT LOWER NO. 1 FLOOR HEAT INSULATOR

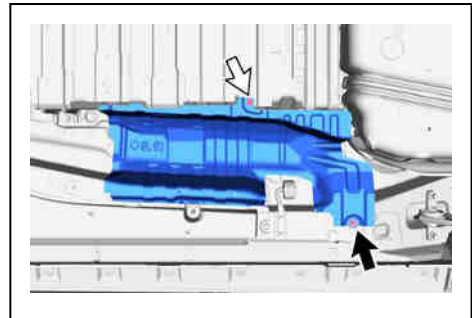
- (1) Remove the nut, bolt and front lower No. 1 floor heat insulator.



	Bolt
	Nut

25. DISCONNECT NO. 3 LIQUID TUBE

CAUTION:

Be sure to wear insulated gloves and protective goggles.

- (1) Remove the bolt and No. 3 liquid tube from the HV supply battery assembly.
- (2) Remove the O-ring from the No. 3 liquid tube.

NOTICE:

Seal the openings of the disconnected parts with vinyl tape to prevent entry of moisture and foreign matter.

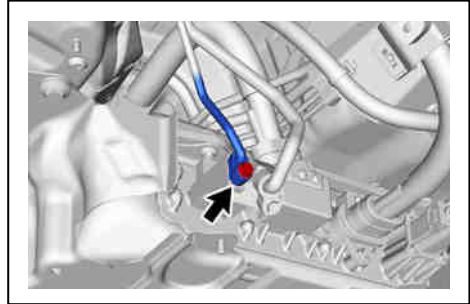

26. DISCONNECT NO. 9 DISCHARGE TUBE

CAUTION:

Be sure to wear insulated gloves and protective goggles.

- (1) Remove the bolt and No. 9 discharge tube from the HV supply battery assembly.
- (2) Remove the O-ring from the No. 9 discharge tube.

NOTICE:

Seal the openings of the disconnected parts with vinyl tape to prevent entry of moisture and foreign matter.

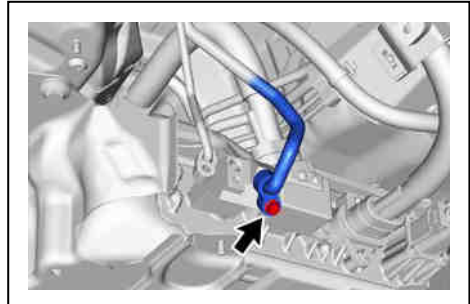

27. DISCONNECT HV FLOOR UNDER WIRE

CAUTION:

Be sure to wear insulated gloves and protective goggles.

NOTICE:

Insulate the disconnected terminals and connector with insulating tape.

- (1) Remove the bolt and disconnect the HV floor under wire.

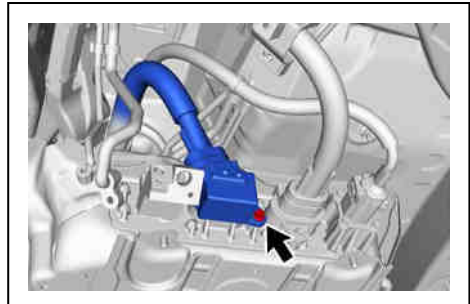

- (2) Remove the bolt and open the wire harness protector as shown in the illustration.

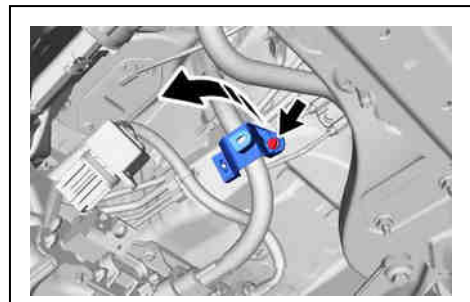

- (3) Remove the bolt and disconnect the HV floor under wire.

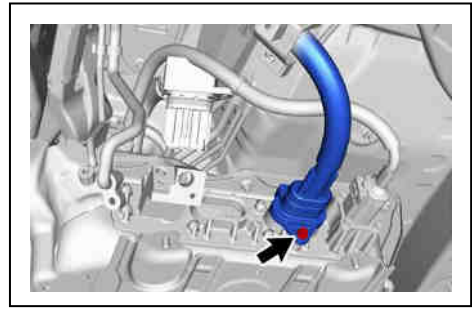

- (4) Disengage the 2 clamps.

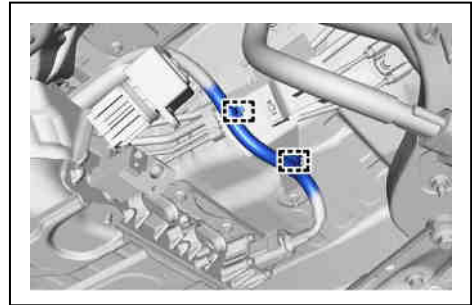

- (5) Disengage the rubber cap and slide it as shown in the illustration.

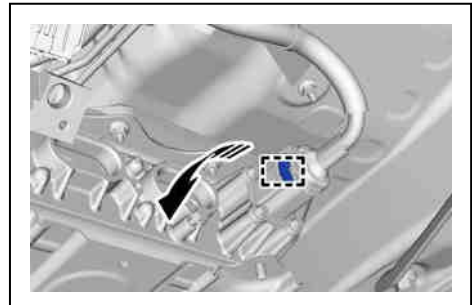

- (6) Using a screwdriver, slide the green-colored lock of the connector as shown in the illustration to release it and disconnect the HV floor under wire.

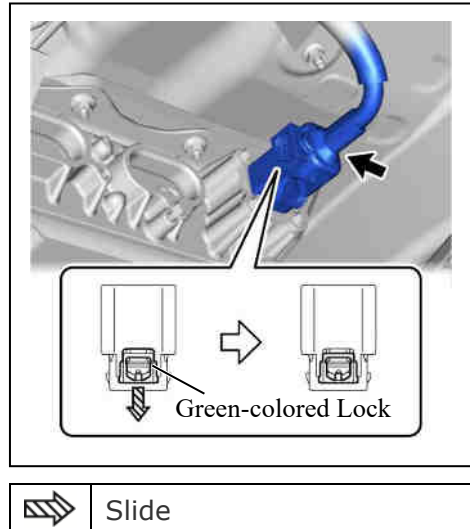

28. DISCONNECT NO. 2 TRACTION BATTERY WIRE

CAUTION:

Be sure to wear insulated gloves and protective goggles.

- (1) Disconnect the 3 No. 2 traction battery wire connectors from the HV supply battery assembly.

NOTICE:

Seal the openings of the disconnected parts with vinyl tape to prevent entry of moisture and foreign matter.

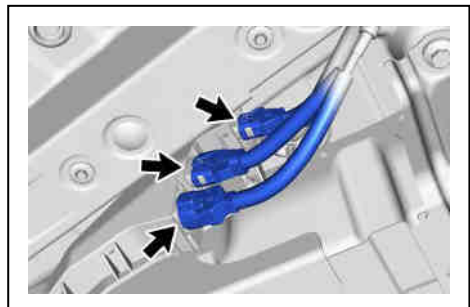

29. REMOVE HV SUPPLY BATTERY ASSEMBLY

CAUTION:

- Because the weight of the HV supply battery assembly is extremely heavy, make sure to follow the work procedures described in this manual.
- If work is not performed according to the procedures described in this manual, there is a danger that the components could fall down.
- Do not damage the HV supply battery assembly with the fork etc.
- Be sure to wear insulated gloves and protective goggles.

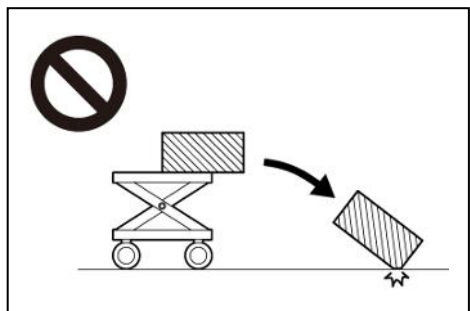

- (1) Using an engine lifter and 4 attachments or equivalent tools, support the HV supply battery assembly as shown in the illustration.

NOTICE:

- Do not allow foreign matter, such as grease or oil, to adhere to the bolts of the HV supply battery assembly.
- To prevent the wire harness from being caught, make sure to bundle the wire harness using insulating tape or equivalent.
- Since the HV supply battery assembly is very heavy, 2 people are needed to remove it. When removing the HV supply battery assembly, be careful not to damage the parts around it.
- When removing/installing/moving the HV supply battery assembly, make sure not to tilt it more than 80°.
- Do not apply any load outside of the area that can touch the ground.

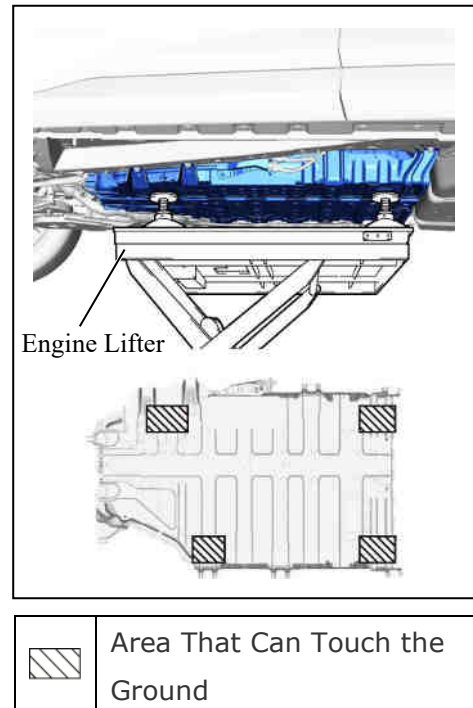

- (2) Remove the 9 bolts.
- (3) Slowly lower the engine lifter to remove the HV supply battery assembly.

NOTICE:

Be careful not to drop the HV supply battery assembly.

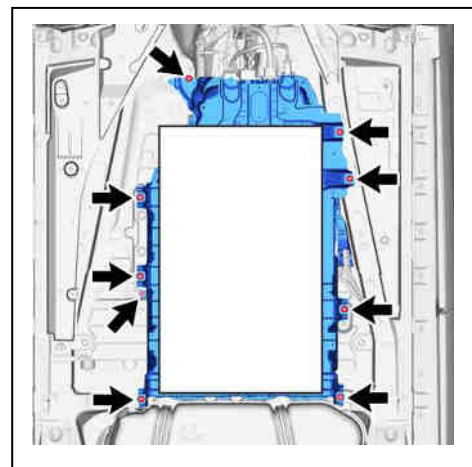

(4) Follow the procedure below when moving the HV supply battery assembly from the engine lifter.

(i) Install the SST at the position shown in the illustration.

SST: 09893-42010

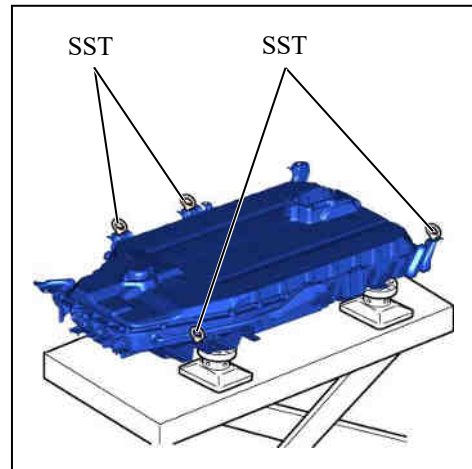

(ii) Using 4 hooks, 4 belt slings and a chain block, hoist the HV supply battery assembly.

NOTICE:

When removing/moving the HV supply battery assembly, make sure not to tilt it more than 80°.

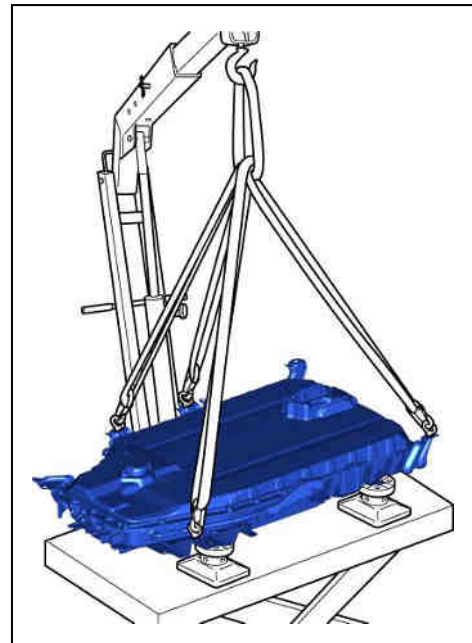

(iii) Using the height adjustable attachment, set so that the HV supply battery assembly is in contact with the position shown in the illustration, and place the HV supply battery assembly on the height adjustable attachment.

NOTICE:

- To prevent the wire harness from being caught, make sure to bundle the wire harness using insulating tape or equivalent.
- When removing/moving the HV supply battery assembly, make sure not to tilt it more than 80°.
- Do not apply any load outside of the area that can touch the ground.
- Do not place the lower surface of the battery on the ground.

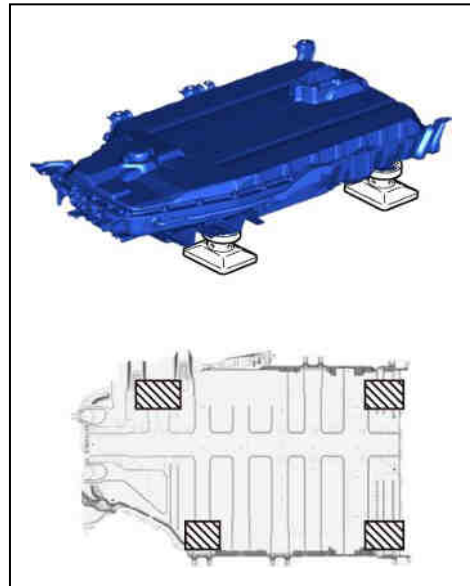

	Area That Can Touch the Ground
------------------------------------------------------------------------------------	--------------------------------